

Specifications

Supply Voltage

- 10 to 30 VDC; 5 volt models: 4.5 to 5.5 VDC
- Polarity Protected

Current Requirements

- 30mA (exclusive of load)

Output Transistors (CURRENT LIMITED)

- NPN: Sink up to 100mA
- PNP: Source up to 100mA
- All outputs are continuously short-circuit protected

Response Time

- Light State response = 600 μ s (2 ms Thru-Beam)
- Dark State response = 600 μ s (2 ms Thru-Beam)

LED Light Source

- Red = 633 nm
- Infrared = 850 nm
- Pulse Modulated

Excess Gain Adjustment

- Sensitivity controlled by a screwdriver adjustment to prevent tampering

Light/Dark "ON" Operation

- Light "ON" achieved by connecting white wire to negative lead
- Dark "ON" achieved by connecting white wire to positive lead

Range

- Dependent on model (See brochure on web - www.ttco.com)

Hysteresis

- Approximately 20% of signal

Light Immunity

- Responds to sensor's pulse-modulated light source, resulting in high immunity to most ambient light, including high intensity strobes.

Diagnostic Indicators

- Red LED = Output Status
- Green LED = Power "ON"

Ambient Temperature

- -40° C to 70° C (-40° F to 158° F)

Rugged Construction

- Chemical resistant, high impact polycarbonate housing
- Waterproof ratings: NEMA 4X, IP66

Product subject to change without notice



P.O. Box 25135, Tampa, FL 33622-5135
Tel (813) 886-4000 / Fax (813) 884-8818
info@ttco.com
ttco.com



070-0171 Rev 2

MINI-EYE™ 18mm



The Tri-Tronics' MINI-EYE™ photoelectric sensors are designed to be low in cost and high in value. They are **waterproof** and are enclosed in a **high-impact** plastic housing. The sensors and light sources are equipped with an excess gain (sensitivity) screwdriver adjustment. The screwdriver adjustment provides additional security to prevent tampering.

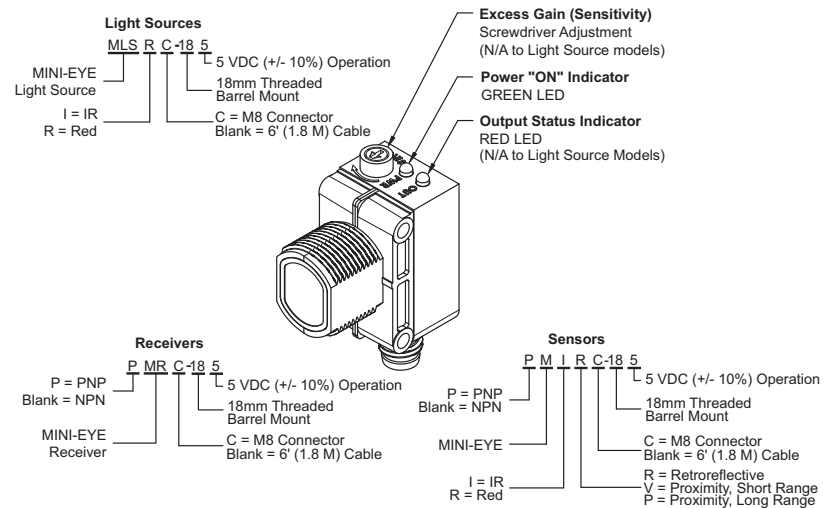

Features & Benefits:

- Excess gain (sensitivity) controlled by a screwdriver adjustment to prevent tampering
- Models available with either Red or IR light source
- Models available with either NPN or PNP output transistor
- Fixed Optics - Proximity, Retroreflective, Polarized Retroreflective, & Thru-Beam
- Light "ON" or dark "ON" selectable by wire
- Immune to indirect ambient light and direct strobes
- Waterproof with high impact plastic housing
- High speed - 600 μ s (1100 μ s Thru-Beam)
- Potted 6' cable or M8 4-pin connector
- Power supply requirements: 10 to 30 VDC; 4.5 to 5.5 VDC for 5 volt models

MINI-EYE™ 18mm ADJUSTMENT PROCEDURES

Proximity or Convergent Sensing Modes

- Step 1: Turn sensitivity adjustment fully counter clockwise (CCW)
 - Step 2: Observe status of LED output indicator
 - Step 3: Place object to be detected directly into the path of the sensor's light beam
 - Step 4: Slowly turn the sensitivity adjustment clockwise (CW) until the output indicator toggles to the opposite state
 - Step 5: Continue to turn the sensitivity adjustment clockwise (CW) to an excess gain point approximately 1/8 turn past the point at which the output LED toggles to the opposite state
- If sensor fails to detect the object with the sensitivity adjustment fully clockwise (CW), move the sensor closer to the object*

Retroreflective Sensing Mode

Visual alignment with the reflector at short range is generally acceptable. The following procedure is suggested when the reflector is located multiple feet away from the sensor.

- Step 1: Point the sensor's light beam away from the reflector
- Step 2: Turn the sensitivity adjustment fully clockwise (CW)
- Step 3: Monitor the output LED indicator while moving the sensor's light beam in a scanning motion, first from left to right and then up and down. Use this technique to locate the mounting position that will ensure the best possible beam alignment with the reflector.
- Step 4: When acceptable beam alignment has been achieved, turn the sensitivity adjustment fully counter clockwise (CCW)
- Step 5: Turn the sensitivity adjustment clockwise (CW) 1/4 turn past the point the output LED indicator toggles to the opposite state.

Opposed Mode - Light Source & Receiver

- Step 1: Point the light beam emitted by the Light Source away from the Receiver.
- Step 2: Turn the Receiver sensitivity adjustment fully clockwise (CW) to its maximum setting.
- Step 3: Monitor the output LED indicator on the Receiver while moving the light beam emitted from the Light Source in a scanning motion, first from left to right and then up and down. Use this technique to locate the mounting position that will ensure the best possible beam alignment with the Receiver.
- Step 4: When acceptable beam alignment has been achieved, turn the sensitivity adjustment fully counter clockwise (CCW).
- Step 5: Turn the Receiver sensitivity adjustment clockwise (CW) 1/4 turn past the point the output LED indicator toggles to the opposite state.

Sensor & Receiver

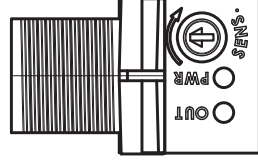

Light Source

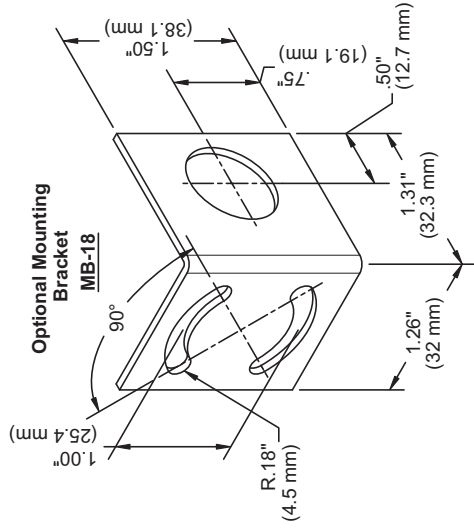
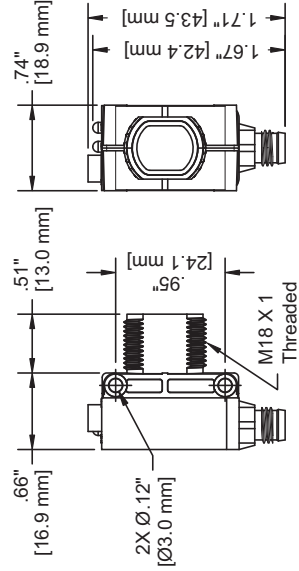
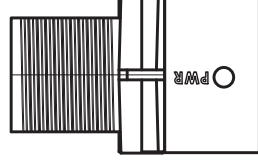

MINI-EYE™ 18mm



Light Sources

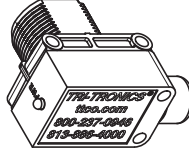

Retroreflective & Proximity Mode Sensors

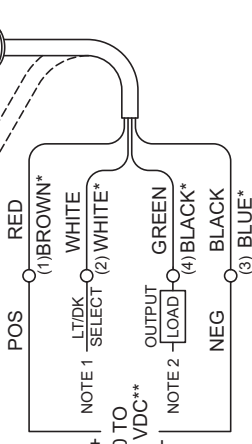
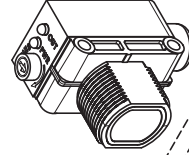

* Sensors With Connectors
** 5 Volt Models: 5 VDC +/- 10%

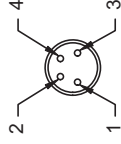

Connector
Pin-Out For
All Models

Note 1: Dark "ON" Operation: Terminate To Positive
Light "ON" Operation: Terminate To Negative

Note 2: NPN (Sink) Output Models: Terminate Load To Positive
PNP (Source) Output Models: Terminate Load To Negative

Choice of: Built-in 6 ft (1.8 m) Cable, or
M8 4-Pin Connector For Use With Optional Cables